

# Quick Start Guide

for mass flow meter & controller

## **IN-FLOW** *High Flow*

F-116AI, F-116BI, F-126AI, F-126BI,  
F-206AI, F-206BI, F-216AI,  
F-216BI

### **IMPORTANT!**

Read carefully before use.  
Keep for future reference.



## Safety First

- ▶ Please read this manual carefully before installing and operating the product.
- ▶ All instructions must be observed, including the online available comprehensive instruction manual of the product.
- ▶ Failure to comply with the instructions may result in material damage and personal injury, including danger to life.
- ▶ Scan the QR code (Product info) on the back cover to download the additional product manuals.
- ▶ If in any doubt: scan the QR code (Service & Support) on the back cover to get in contact with Bronkhorst.
  
- ▶ Before working on the product: de-energize the product.
- ▶ Take appropriate measures to prevent electrostatic discharge (ESD) while working on the product.
- ▶ Always check for fluid leakage before and after working on the product.
  
- ▶ The product may run hot during operation depending on process fluid and ambient temperature.
- ▶ Allow the product to cool down before carrying out any work.
- ▶ If necessary, wear protective gloves.

## Intended Use

The product has been developed to measure and/or control mass flow rates of clean and dry gases in a fluid system. The product is suited for general-purpose indoor (dry) applications, like laboratories and machine enclosures, as well as for sheltered outdoor applications, like installations in plant constructions. Any other use is considered not intended.

- ▶ Observe the details on the serial number label and this guide to ensure correct use.

## Notices for the user

The product requires professional experience and knowledge of installation, operational requirements of the relevant industry, and knowledge of the type of application and national requirements according to relevant standards and regulations.

## Modifications

The product may not be disassembled or modified in any way or for any purpose. Unauthorized modifications can undo safety features, compromise system specifications and cause failure to comply with applicable laws, regulations and directives.

Any unauthorized modification will be considered as unintended and improper use.



## **Process fluid**

The product is intended for the use of the process fluid indicated on the serial number label.

- ▶ Make sure that the process fluid used is identical to that indicated on the serial number label.

In any other case:

- ▶ Refer to the online available comprehensive manual for whether the required process fluid is suitable for the product type and wetted materials used.
- ▶ If in any doubt: scan the QR code (Service & Support) on the back cover to get in contact with Bronkhorst.

The user is responsible for taking the necessary safety measures to prevent damage and/or injury while working with the product and process fluid.

- ▶ Please refer to the on-site available material safety data sheet of the process fluid (MSDS) before working on the product.

## **System pressure**

The maximum permissible pressure is indicated in the technical specifications table in this guide. Exceeding this value may result in product damage or leakage.

- ▶ Make sure that the maximum permissible pressure of the product is equal to or greater than the process conditions of the system.

## **Product types**

This document only applies to the product types indicated on the front cover of this Quick Start Guide.

- ▶ Check whether this Quick Start Guide applies to the product.

## **About this Quick Start Guide**



All illustrations are general representations and may differ from the actual configuration and product type.

This Quick Start Guide is intended for commissioning the product in a non-critical process. It will guide the user in controlling and monitoring research and pilot setups using Bronkhorst FlowSuite software.

- ▶ Prior to work, check whether a newer version of this document is available on the Bronkhorst website.
- ▶ Scan the QR code (Product info) on the back cover to go the product landing page to download the latest version.



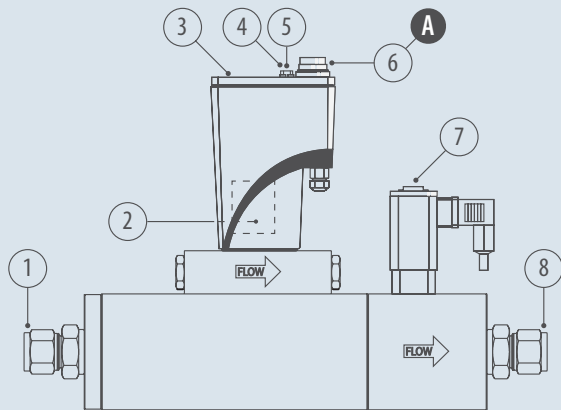

### **IN-FLOW** *High Flow*

- |                         |                  |
|-------------------------|------------------|
| 1. Fluid inlet          | 5. Status LEDs   |
| 2. Serial number label  | 6. Connector     |
| 3. Connector (optional) | 7. Control valve |
| 4. Switch/Push button   | 8. Fluid outlet  |



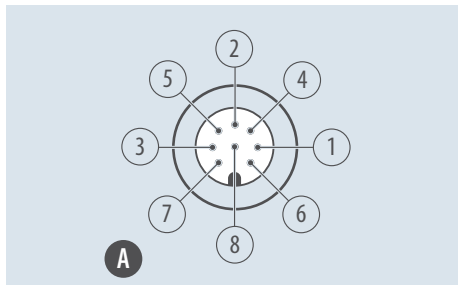

### Pinout - 8 DIN

1. TX-RS232/BUS
2. Analog output
3. Analog input
4. 0 V power
5. Custom\*
6. RX-RS232/BUS
7. +Us (15 ... 24 Vdc)
8. 0 V sense

\* Default disabled, 0 Vdc

### Before Installation

- ▶ Check the contents of the packaging box for damage.
- ▶ Install only undamaged products.

### Label 'Pressure Tested'

The red label 'Pressure Tested' indicates that the product has been tested and approved.

- ▶ Check if the label is on the product.
- In case the label is missing, the product should be returned:
- ▶ Scan the QR code (Service & Support) on the back cover to get in contact with a Bronkhorst representative.

### Product specifications

- ▶ Verify that the specifications on the serial number label match the application.
- ▶ Make sure that the product is sufficiently clean for its intended use.

### Install Bronkhorst FlowSuite

- ▶ Scan the QR code (Service & Support) on the back cover.
- ▶ Go to the Bronkhorst website and select your operating system to download Bronkhorst FlowSuite. For download information, see the back cover of this manual.
- ▶ Follow the on-screen instructions to install the application on a Windows PC.



## Mounting location

To ensure reliable measurements, it is important to choose a correct mounting location. For optimal performance, observe the following guidelines:

- ▶ Install the product on a flat, rigid, and clean surface [1].
- ▶ Avoid installation close to mechanical vibrations [2].
- ▶ Avoid installation close to magnetic field sources.
- ▶ Avoid installation close to heat sources [3].
- ▶ Mount the product to a rigid construction using the mounting holes at the bottom of the base.

|             |     |     |     |
|-------------|-----|-----|-----|
| Bolt size   | M3  | M4  | M5  |
| Torque [Nm] | 0,5 | 1,2 | 2,4 |

- ▶ See online available dimensional drawings for further details.

## Pressure rating

- ▶ If applicable: install the process connections according to the manufacturer's instructions.
- ▶ Check the maximum permissible system pressure in the technical specifications table in this guide.
- ▶ Make sure that the pressure rating of the product, is equal to or greater than the maximum applied system pressure.

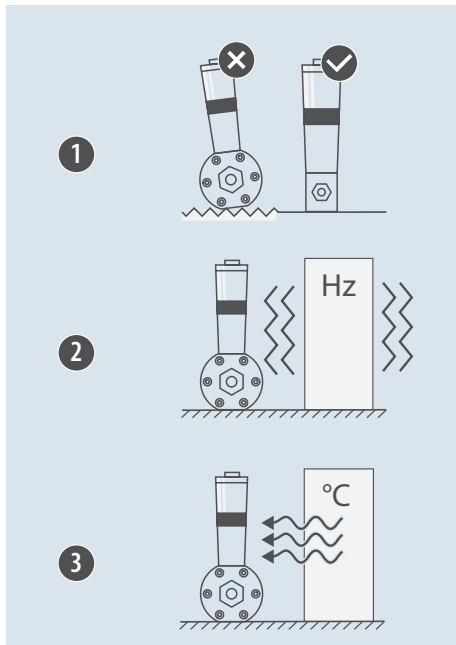

## Fluid line connection



### CAUTION

#### Risk of personal injury due to fluid leakage!

Unsuitable piping material and loose connectors can lead to fluid leakage and severe injury.

- ▶ Use piping and tubing that are suitable for the operating conditions of the application.
- ▶ Check all connections for fluid leakage before and after applying fluid pressure.

- ▶ Cut the pipes/tubing squarely.
- ▶ Make sure that the pipes are clean and deburred before mounting.

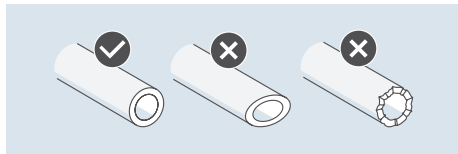

- ▶ Connect the piping without stress to the product fluid inlet and fluid outlet.
- ▶ Tighten fluid connections according to the manufacturer's instructions.
- ▶ Clean all connectors and tubing from dirt and debris.

## Electrical connection



For basic setup, it is recommended to use Bronkhorst® accessories (not included) as described in this manual.

- ▶ Connect the product to the PC by using a T-part 8DIN/SubD-9 cable and USB converter.
- ▶ Connect the PIPS-IN-8DIN power supply to the T-part.
- ▶ Turn on power.

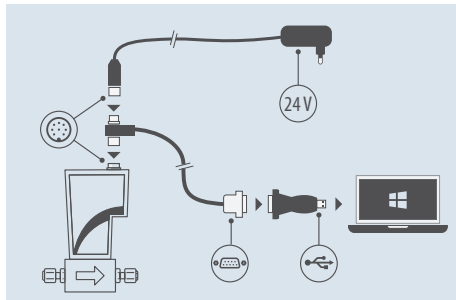

When using third-party power supply and cables:

- ▶ Make sure that the maximum power of the power supply is sufficient to power the product.
- ▶ Check the pinout diagram for the correct pin layout.



## Adding the product to Bronkhorst FlowSuite

When Bronkhorst FlowSuite is started, the software will automatically search for connected products. All found products are displayed in the left pane.

- ▶ Use the refresh option to check for newly connected products. If the product is not found, it may not be set to serial RS-232.
- ▶ Follow the instructions on the next page to set the product to serial RS-232.

## Commissioning

- ▶ Apply fluid pressure gradually to prevent pressure shocks [1].
- ▶ Warm up the product for at least 30 minutes before starting measurement [2].

## Adjusting Zero Point

To ensure correct measurements, adjust Zero Point in the following situations: before first use and after remounting [3].

To start adjusting Zero Point:

- ▶ Open Bronkhorst FlowSuite on the PC.
- ▶ Select the product in the left pane.
- ▶ Go to the Actions menu.
- ▶ Press the button Auto Zero.
- ▶ Follow the on-screen instructions.

The product is ready for use!

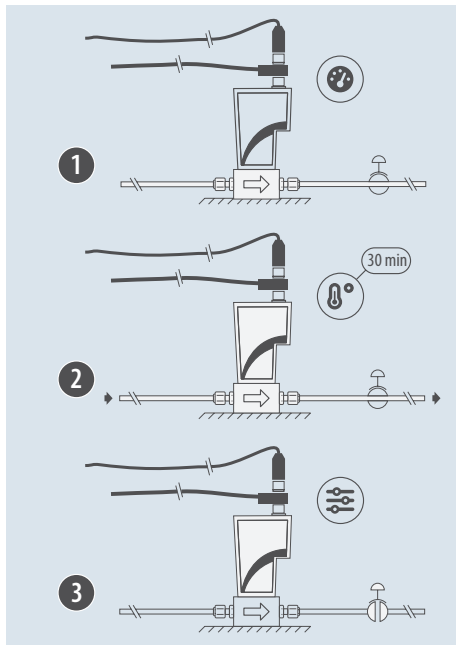



## Switching to serial RS-232

If a connection between the product and Bronkhorst FlowSuite cannot be established, the switch/push button can be used to enter the configuration mode and enable the required RS-232 communication. To activate the RS232 communication:

- ▶ Switch off the power supply of the product.
- ▶ Push and hold the button while switching on the power.
- ▶ Release the button after 12 to 16 sec. when both LED's (red and green) are fast blinking.

If the RS-232 communication is active, the green LED will long flash.

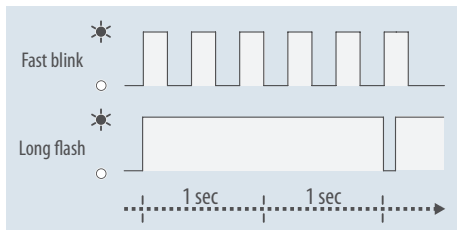

To return to the factory configuration:

- ▶ Repeat the procedure as described above.

## Product status in Bronkhorst FlowSuite

In Bronkhorst FlowSuite, an icon is displayed next to the product in the left pane. The icon indicates the status of the product. When selecting a product from the left pane, more status information is given in the overview screen.

The icon colors are based on the NAMUR NE 107 standard and are a simplified representation of the diagnostic data of the product.

| Icon | Icon color | Product status  |
|------|------------|---|
|      | Green      | Normal operation<br>- Valid output signal                   |
|      | Blue       | Maintenance required<br>- Output signal still valid         |
|      | Yellow     | Out of specification<br>- Signal out of the specified range |
|      | Orange     | Check function<br>- Output signal temporary non-valid       |
|      | Red        | Critical failure<br>- Non-valid output signal               |

Information on the Status LED on the product can be found in the online available comprehensive manual.



## Maintenance

Although no routine maintenance is required, to ensure that the product works correctly and safely, a regular (visual) inspection is recommended.

### Check prior to each use

- ▶ Check cabling for proper connection, damage and wear.
- ▶ Check fluid lines and connections for leaks, damage and wear.
- ▶ Carry out repairs immediately.

### Removing contamination

In case of clogging or contamination of the fluid path, purging the product and fluid lines may solve the issue.

- ▶ Purge the fluid path with a clean, dry and inert gas.

### Cleaning exterior

- ▶ Clean the product with a dry or slightly damp cloth.
- ▶ Avoid using abrasive or aggressive cleaning agents.

## Technical specifications

| Description               | Unit           | Value  |
|---------------------------|----------------|--|
| Maximum fluid pressure    | bar(g)         | See serial number label                      |
| Permissible fluid temp.   | °C (°F)        | -10 ... 70 (14 ... 158)                      |
| Permissible ambient temp. | °C (°F)        | -10 ... 70 (14 ... 158)                      |
| Storage conditions        | °C (°F)<br>%RH | 0 ... 50 (32 ... 122)<br>95 (non condensing) |
| Max. install. altitude    | m (ft)         | 2000 (6560)                                  |
| Warm-up time              | min.           | 30   |
| Ingress protection        |                | IP65   |
| Power input               | Vdc            | 15 ... 24 (±10 %)                            |
| Power connector           |                | 8 DIN (male)                                 |
| Process connections       |                | • Compression type<br>• Face seal couplings  |



## Service and support

If you have a question about the product or it does not meet the specifications as ordered, do not hesitate to contact your Bronkhorst representative.

- ▶ To help you quickly, make sure you have the serial number of the product at hand.
- ▶ Scan the QR code (Service) on the back of this manual to get in touch.

## Customer Care

No matter the time zone, our experts within the Customer Care department are available to answer your request immediately or take appropriate further action.

For information about Bronkhorst® and worldwide service addresses, please visit our website.

- ▶ Scan the QR code (Service) on the back of this guide to get in touch.

## Conditions of sales

For information about the conditions of sales, please visit the Bronkhorst website:

**[www.bronkhorst.com/about/conditions-of-sales](http://www.bronkhorst.com/about/conditions-of-sales)**

## Disposal - end of life



This symbol means that the product must not be disposed of with other waste, and instead must be returned (WEEE). Bronkhorst will take care of proper dismantling, recycling and/or reuse. By ensuring this product is disposed of correctly, you will help prevent potential negative consequences for the environment caused by inappropriate waste handling of this product.

## Within the EU:

Return the item(s) following the return instructions on our website.

- ▶ Mention during the return process that the product is being returned for disposal.

## Outside the EU:

Disposal of electrical and electronic equipment (EEE) may be subject to local or national directives and/or legislation.

- ▶ Consult local or national authorities to learn how to handle EEE properly in your area.



## Declaration of conformity

**CE** The CE mark on the product indicates that it complies with requirements imposed by the European Union.

**UK  
CA** The UKCA mark on the product indicates that it complies with requirements imposed by Great Britain.

The full text of the applicable declarations of conformity are available at the following web address:

<https://www.bronkhorst.com/downloads>.

© 2024 Bronkhorst High-Tech B.V. - All rights reserved  
Bronkhorst® is a registered trademark. All trademarks are the property of their respective owners.











Bronkhorst High-Tech B.V.

Nijverheidsstraat 1a

NL-7261 AK Ruurlo, The Netherlands

+31 573 45 88 00

info@bronkhorst.com

www.bronkhorst.com



Service & Support



Bronkhorst FlowSuite



Product Info



9.17.201A • 2024-03